

Formulae and Tables

for use in the State Examinations

Draft for consultation

Observations are invited on this draft booklet of *Formulae and Tables*, which is intended to replace the *Mathematics Tables* for use in the state examinations.

In 2007, the State Examinations Commission convened a working group to review and update the *Mathematics Tables* booklet, which is provided to candidates for use in the state examinations. The Department of Education and Science and the National Council for Curriculum and Assessment are represented on the working group.

The group has carried out some consultation and now presents this draft for wider consultation.

This draft is available in English only. The final booklet will be provided in both Irish and English.

Anyone receiving this document should note its draft status, and should not assume that content currently in the draft will be included in the final version. The final version will be circulated to all schools in advance of its introduction in the state examinations.

The working group recognises that the *Mathematics Tables* booklet is used by other institutions in their own examinations and by various individuals for other purposes. Whereas the needs of such users will be noted, final decisions will be taken in the context of the booklet's primary purpose as a reference for candidates taking examinations conducted by the State Examinations Commission.

Comments should be forwarded by e-mail to tables@examinations.ie before 31 May 2008.

Contents

Length and area	4
Surface area and volume.....	5
Area approximations.....	6
Trigonometry	7
Co-ordinate geometry	10
Geometry	11
Algebra	12
Sequences and series	12
Number sets – notation	13
Calculus	14
Financial mathematics	16
Statistics and probability.....	18
Units of measurement.....	26
Common quantities, their symbols and units of measurement	28
Frequently used constants.....	33
Particle physics	34
Mechanics.....	36
Heat and temperature.....	41
Waves	41
Electricity.....	43
Modern physics.....	45
Electrical circuit symbols	46
The elements.....	51

Length and area

Parallelogram

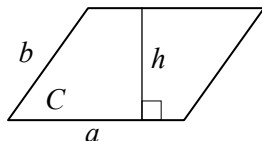

$$\text{Perimeter} = 2a + 2b$$

$$\begin{aligned}\text{Area} &= ah \\ &= ab \sin C\end{aligned}$$

Circle / Disc

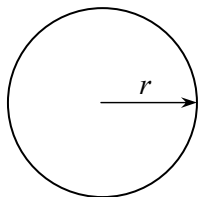

$$\text{Length of circle} = 2\pi r$$

$$\text{Area of disc} = \pi r^2$$

Arc / Sector

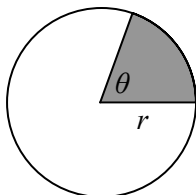

When θ is in radians:

$$\text{Length of arc} = r\theta$$

$$\text{Area of sector} = \frac{1}{2}r^2\theta$$

When θ is in degrees:

$$\text{Length of arc} = 2\pi r \left(\frac{\theta}{360^\circ} \right)$$

$$\text{Area of sector} = \pi r^2 \left(\frac{\theta}{360^\circ} \right)$$

Triangle

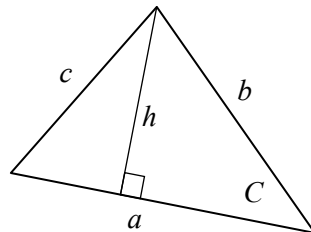

$$\text{Perimeter} = a + b + c$$

$$\text{Area} = \frac{1}{2}ah$$

$$= \frac{1}{2}ab \sin C$$

$$= \sqrt{s(s-a)(s-b)(s-c)},$$

$$\text{where } s = \frac{a+b+c}{2}.$$

Surface area and volume

Cylinder

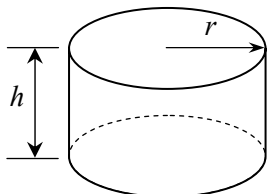

$$\text{Curved surface area} = 2\pi rh$$

$$\text{Volume} = \pi r^2 h$$

Cone

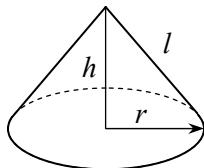

$$\text{Curved surface area} = \pi rl$$

$$\text{Volume} = \frac{1}{3} \pi r^2 h$$

Sphere

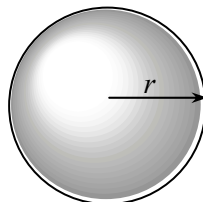

$$\text{Surface area} = 4\pi r^2$$

$$\text{Volume} = \frac{4}{3} \pi r^3$$

Frustum of a cone

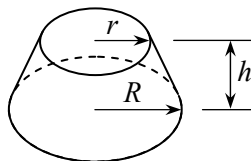

$$\text{Volume} = \frac{1}{3} \pi h (R^2 + Rr + r^2)$$

Solid of uniform cross-section (prism)

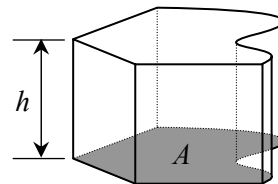

$$\text{Volume} = Ah, \text{ where } A \text{ is the area of the base.}$$

Pyramid on any base

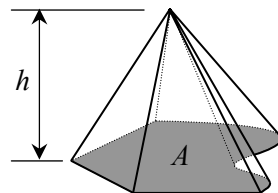

$$\text{Volume} = \frac{1}{3} Ah, \text{ where } A \text{ is the area of the base.}$$

Area approximations

Trapezoidal rule:

$$\text{Area} \approx \frac{h}{2} [y_1 + y_n + 2(y_2 + y_3 + y_4 + \dots + y_{n-1})]$$

$$\text{or} \approx \frac{h}{2} [\text{first} + \text{last} + \text{twice the rest}]$$

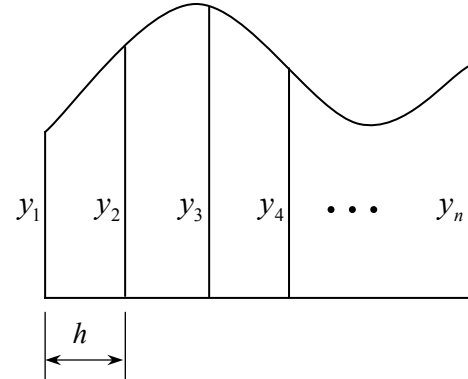

Simpson's rule:

$$\text{Area} \approx \frac{h}{3} [y_1 + y_n + 2(y_3 + y_5 + \dots + y_{n-2}) + 4(y_2 + y_4 + \dots + y_{n-1})], \text{ (where } n \text{ is odd)}$$

$$\text{or} \approx \frac{h}{3} [\text{first} + \text{last} + \text{twice the odds} + \text{four times the evens}]$$

Trigonometry

Definitions

$$\tan A = \frac{\sin A}{\cos A}$$

$$\cot A = \frac{1}{\tan A}$$

$$\sec A = \frac{1}{\cos A}$$

$$\operatorname{cosec} A = \frac{1}{\sin A}$$

Trigonometric ratios of certain angles

A (degrees)	0°	90°	180°	270°	30°	45°	60°
A (radians)	0	$\frac{\pi}{2}$	π	$\frac{3\pi}{2}$	$\frac{\pi}{6}$	$\frac{\pi}{4}$	$\frac{\pi}{3}$
$\cos A$	1	0	-1	0	$\frac{\sqrt{3}}{2}$	$\frac{1}{\sqrt{2}}$	$\frac{1}{2}$
$\sin A$	0	1	0	-1	$\frac{1}{2}$	$\frac{1}{\sqrt{2}}$	$\frac{\sqrt{3}}{2}$
$\tan A$	0	not defined	0	not defined	$\frac{1}{\sqrt{3}}$	1	$\sqrt{3}$

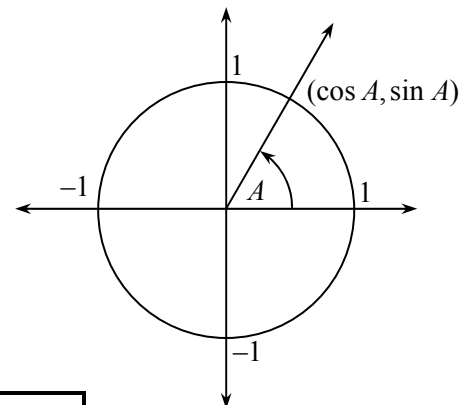

Basic identities

$$\cos^2 A + \sin^2 A = 1$$

$$\cos(-A) = \cos A$$

$$\sin(-A) = -\sin A$$

$$\tan(-A) = -\tan A$$

Compound angle formulae

$$\cos(A + B) = \cos A \cos B - \sin A \sin B$$

$$\cos(A - B) = \cos A \cos B + \sin A \sin B$$

$$\sin(A + B) = \sin A \cos B + \cos A \sin B$$

$$\sin(A - B) = \sin A \cos B - \cos A \sin B$$

$$\tan(A + B) = \frac{\tan A + \tan B}{1 - \tan A \tan B}$$

$$\tan(A - B) = \frac{\tan A - \tan B}{1 + \tan A \tan B}$$

Double angle formulae

$$\cos 2A = \cos^2 A - \sin^2 A$$

$$\sin 2A = 2 \sin A \cos A$$

$$\tan 2A = \frac{2 \tan A}{1 - \tan^2 A}$$

$$\cos 2A = \frac{1 - \tan^2 A}{1 + \tan^2 A}$$

$$\sin 2A = \frac{2 \tan A}{1 + \tan^2 A}$$

$$\cos^2 A = \frac{1}{2}(1 + \cos 2A)$$

$$\sin^2 A = \frac{1}{2}(1 - \cos 2A)$$

Products to sums and differences

$$2 \cos A \cos B = \cos(A + B) + \cos(A - B)$$

$$2 \sin A \cos B = \sin(A + B) + \sin(A - B)$$

$$2 \sin A \sin B = \cos(A - B) - \cos(A + B)$$

$$2 \cos A \sin B = \sin(A + B) - \sin(A - B)$$

Sums and differences to products

$$\cos A + \cos B = 2 \cos \frac{A+B}{2} \cos \frac{A-B}{2}$$

$$\cos A - \cos B = -2 \sin \frac{A+B}{2} \sin \frac{A-B}{2}$$

$$\sin A + \sin B = 2 \sin \frac{A+B}{2} \cos \frac{A-B}{2}$$

$$\sin A - \sin B = 2 \cos \frac{A+B}{2} \sin \frac{A-B}{2}$$

Trigonometry of the triangle

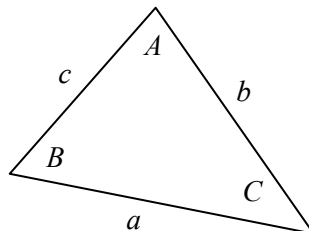

$$\text{Area} = \frac{1}{2} ab \sin C$$

$$\text{Sine rule: } \frac{a}{\sin A} = \frac{b}{\sin B} = \frac{c}{\sin C}$$

$$\text{Cosine rule: } a^2 = b^2 + c^2 - 2bc \cos A$$

In a right-angled triangle,

$$\sin = \frac{\text{opposite}}{\text{hypotenuse}}$$

$$\cos = \frac{\text{adjacent}}{\text{hypotenuse}}$$

$$\tan = \frac{\text{opposite}}{\text{adjacent}}$$

Co-ordinate geometry

Line

$$\text{Slope: } m = \frac{y_2 - y_1}{x_2 - x_1}$$

$$\text{Distance} = \sqrt{(x_2 - x_1)^2 + (y_2 - y_1)^2}$$

$$\text{Midpoint} = \left(\frac{x_1 + x_2}{2}, \frac{y_1 + y_2}{2} \right)$$

$$\text{Equation of a line: } y - y_1 = m(x - x_1) \text{ or } y = mx + c$$

$$\text{Area of a triangle with one vertex at the origin} = \frac{1}{2} |x_1 y_2 - x_2 y_1|$$

$$\text{Point dividing a line segment in the ratio } a : b = \left(\frac{bx_1 + ax_2}{a + b}, \frac{by_1 + ay_2}{a + b} \right)$$

$$\text{Distance from a point to a line} = \frac{|ax_1 + by_1 + c|}{\sqrt{a^2 + b^2}}$$

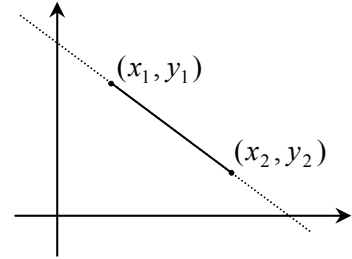

Circle

Equation of a circle, centre (h, k) , radius r : $(x - h)^2 + (y - k)^2 = r^2$

Circle $x^2 + y^2 + 2gx + 2fy + c = 0$ has centre $(-g, -f)$ and radius $\sqrt{g^2 + f^2 - c}$

Tangent to circle through given point: $(x - h)(x_1 - h) + (y - k)(y_1 - k) = r^2$ or
 $xx_1 + yy_1 + g(x + x_1) + f(y + y_1) + c = 0$

Geometry

Notation

Line through A and B : \overleftrightarrow{AB}

Line segment from A to B : \overline{AB}

Distance from A to B : AB

Vector from A to B : \overrightarrow{AB}

Vector from origin O to A : $\overrightarrow{OA} = \mathbf{a}$

Vector operations

$\mathbf{v}_1 = x_1\mathbf{i} + y_1\mathbf{j}$, $\mathbf{v}_2 = x_2\mathbf{i} + y_2\mathbf{j}$

Scalar product: $\mathbf{v}_1 \cdot \mathbf{v}_2 = x_1x_2 + y_1y_2$
 $= |\mathbf{v}_1||\mathbf{v}_2|\cos\theta$

Norm: $|\mathbf{v}| = \sqrt{x^2 + y^2}$

Algebra

Roots of quadratic equation: $x = \frac{-b \pm \sqrt{b^2 - 4ac}}{2a}$

Binomial theorem: $(x + y)^n = \sum_{r=0}^n \binom{n}{r} x^{n-r} y^r = \binom{n}{0} x^n + \binom{n}{1} x^{n-1} y + \binom{n}{2} x^{n-2} y^2 + \dots + \binom{n}{r} x^{n-r} y^r + \dots + \binom{n}{n} y^n$

De Moivre's theorem: $[r(\cos \theta + i \sin \theta)]^n = r^n (\cos n\theta + i \sin n\theta) = r^n e^{in\theta}$ or $(r \operatorname{cis} \theta)^n = r^n \operatorname{cis}(n\theta)$

Inverse of matrix $A = \begin{pmatrix} a & b \\ c & d \end{pmatrix}$: $\frac{1}{\det A} \begin{pmatrix} d & -b \\ -c & a \end{pmatrix}$, where $\det A = ad - bc$

Sequences and series

Arithmetic sequence or series

$$T_n = a + (n-1)d$$

$$S_n = \frac{n}{2} [2a + (n-1)d]$$

Geometric sequence or series

$$T_n = ar^{n-1}$$

$$S_n = \frac{a(1-r^n)}{1-r}$$

$$S_\infty = \frac{a}{1-r}, \text{ where } |r| < 1$$

Number sets – notation

Natural numbers: $\mathbf{N} = \{1, 2, 3, 4, \dots\}$

Whole numbers: $\mathbf{W} = \{0, 1, 2, 3, 4, \dots\}$

Integers: $\mathbf{Z} = \{\dots - 3, -2, -1, 0, 1, 2, 3, \dots\}$

Rational numbers: $\mathbf{Q} = \left\{ \frac{p}{q} \mid p \in \mathbf{Z}, q \in \mathbf{Z}, q \neq 0 \right\}$

Real numbers: \mathbf{R}

Complex numbers: $\mathbf{C} = \{a + bi \mid a \in \mathbf{R}, b \in \mathbf{R}, i^2 = -1\}$

Calculus

Differentiation

$f(x)$	$f'(x)$
x^n	nx^{n-1}
$\ln x$	$\frac{1}{x}$
e^x	e^x
e^{ax}	ae^{ax}
a^x	$a^x \ln a$
$\cos x$	$-\sin x$
$\sin x$	$\cos x$
$\tan x$	$\sec^2 x$
$\cos^{-1} \frac{x}{a}$	$-\frac{1}{\sqrt{a^2 - x^2}}$
$\sin^{-1} \frac{x}{a}$	$\frac{1}{\sqrt{a^2 - x^2}}$
$\tan^{-1} \frac{x}{a}$	$\frac{a}{a^2 + x^2}$

Product rule

$$y = uv \Rightarrow \frac{dy}{dx} = u \frac{dv}{dx} + v \frac{du}{dx}$$

Chain rule

$$y = u(v(x)) \Rightarrow \frac{dy}{dx} = \frac{du}{dv} \frac{dv}{dx}$$

Newton-Raphson Iteration

$$x_{n+1} = x_n - \frac{f(x_n)}{f'(x_n)}$$

Maclaurin series

$$f(x) = f(0) + f'(0)x + \frac{f''(0)}{2!}x^2 + \dots + \frac{f^{(r)}(0)}{r!}x^r + \dots$$

Taylor series

$$f(x+h) = f(x) + hf'(x) + \frac{h^2}{2!}f''(x) + \dots + \frac{h^r}{r!}f^{(r)}(x) + \dots$$

Quotient rule

$$y = \frac{u}{v} \Rightarrow \frac{dy}{dx} = \frac{v \frac{du}{dx} - u \frac{dv}{dx}}{v^2}$$

Integration

Constants of integration omitted.

$f(x)$	$\int f(x)dx$
$x^n, (n \neq -1)$	$\frac{x^{n+1}}{n+1}$
$\frac{1}{x}$	$\ln x $
e^x	e^x
e^{ax}	$\frac{1}{a}e^{ax}$
$a^x (a > 0)$	$\frac{a^x}{\ln a}$
$\cos x$	$\sin x$
$\sin x$	$-\cos x$
$\tan x$	$\ln \sec x $
$\frac{1}{\sqrt{a^2 - x^2}} (a > 0)$	$\sin^{-1} \frac{x}{a}$
$\frac{1}{x^2 + a^2} (a > 0)$	$\frac{1}{a} \tan^{-1} \frac{x}{a}$

Integration by parts

$$\int u dv = uv - \int v du$$

Solid of revolution about x-axis

$$\text{Volume} = \int_{x=a}^{x=b} \pi y^2 dx$$

Financial mathematics

In all of the following, t is the time in years and i is annual rate of interest, depreciation or growth, expressed as a decimal or fraction (so that, for example, $i = 0.08$ represents a rate of 8%)¹.

Compound interest: $F = P(1+i)^t$ (F = final value. P = principal)

Present value: $P = \frac{F}{(1+i)^t}$ (F = final value. P = present value)

Depreciation – reducing balance method: $F = P(1-i)^t$ (P = initial value. F = later value.)

Depreciation – straight line method: Annual depreciation = $\frac{\text{initial cost} - \text{residual value}}{\text{useful economic life}}$

Amortisation (mortgages and loans – equal repayments at equal intervals):

$$R = A \frac{i(1+i)^t}{(1+i)^t - 1} \quad (R = \text{repayment amount, } A = \text{amount advanced})$$

¹ The formulae also apply when compounding at equal intervals other than years. In such cases, t is measured in the relevant periods of time, and i is the period rate.

Annual percentage rate (APR) – statutory formula

The APR is the value of i (expressed as a percentage) for which the sum of the present values of all advances is equal to the sum of the present values of all repayments. That is, the value of i for which the following equation holds:

$$\sum_{k=1}^{k=M} \frac{A_k}{(1+i)^{T_k}} = \sum_{j=1}^{j=m} \frac{R_j}{(1+i)^{t_j}}$$

where:

M is the number of advances

A_k is the amount of advance k

T_k is the time in years from the relevant date to advance k

m is the number of repayments

R_j is the amount of repayment j

t_j is the time in years from the relevant date to instalment j .

Converting period rate to APR/AER

$$i = (1 + r)^m - 1$$

where:

i is the APR or AER (expressed as a decimal)

r is the period rate (expressed as a decimal)

m is the number of periods in one year.

Statistics and probability

Mean

From list: $\mu = \frac{\Sigma x}{n}$

From frequency table: $\mu = \frac{\Sigma fx}{\Sigma f}$

Standard deviation

From list: $\sigma = \sqrt{\frac{\Sigma(x - \mu)^2}{n}}$

From frequency table: $\sigma = \sqrt{\frac{\Sigma f(x - \mu)^2}{\Sigma f}}$

Sampling

The sample mean \bar{x} is an unbiased estimator of the population mean μ . The adjusted sample standard

deviation $s = \sqrt{\frac{\Sigma(x - \mu)^2}{n - 1}}$ is an unbiased estimator of the population standard deviation σ .

The standard error of the mean is $\frac{\sigma}{\sqrt{n}}$ and the

standard error of the proportion is $\sqrt{\frac{pq}{n}}$.

Hypothesis testing

Tukey quick test:

Significance level	5%	1%	0.1%
Critical value of tail-count	7	10	13

t -test:
$$t = \frac{\bar{X} - \mu}{\left(\frac{s}{\sqrt{n}}\right)}$$

χ^2 -test:
$$\chi^2 = \sum_{i=1}^k \frac{(O_i - E_i)^2}{E_i}$$

Probability distributions

Binomial distribution:

$$P(r) = \binom{n}{r} p^r q^{n-r}$$

$$\mu = np$$

$$\sigma = \sqrt{npq}$$

Poisson distribution:

$$P(r) = e^{-\lambda} \frac{\lambda^r}{r!}, \quad \lambda = np$$

$$\mu = \lambda$$

$$\sigma = \sqrt{\lambda}$$

Normal (Gaussian) distribution:

$$f(x) = \frac{1}{\sigma\sqrt{2\pi}} e^{-\frac{(x-\mu)^2}{2\sigma^2}}$$

Standard normal distribution:

$$f(z) = \frac{1}{\sqrt{2\pi}} e^{-\frac{1}{2}z^2}$$

Standardising formula: $z = \frac{x - \mu}{\sigma}$

Binomial coefficients

$$\binom{n}{r} = {}^n C_r = C(n, r) = \frac{n!}{r!(n-r)!}$$

Some values of ${}^n C_r$:

$n \backslash r$	0	1	2	3	4	5	6	7	8
0	1								
1	1	1							
2	1	2	1						
3	1	3	3	1					
4	1	4	6	4	1				
5	1	5	10	10	5	1			
6	1	6	15	20	15	6	1		
7	1	7	21	35	35	21	7	1	
8	1	8	28	56	70	56	28	8	1
9	1	9	36	84	126	126	84	36	9
10	1	10	45	120	210	252	210	120	45
11	1	11	55	165	330	462	462	330	165
12	1	12	66	220	495	792	924	792	495
13	1	13	78	286	715	1287	1716	1716	1287
14	1	14	91	364	1001	2002	3003	3432	3003
15	1	15	105	455	1365	3003	5005	6435	6435

Area under the standard normal curve

$$P(z \leq z_1) = \frac{1}{\sqrt{2\pi}} \int_{-\infty}^{z_1} e^{-\frac{1}{2}z^2} dz$$

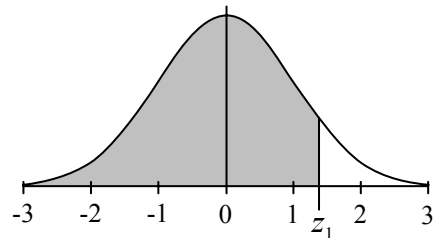

z_1	0-00	0-01	0-02	0-03	0-04	0-05	0-06	0-07	0-08	0-09
0-0	0-5000	5040	5080	5120	5160	5199	5239	5279	5319	5359
0-1	0-5398	5438	5478	5517	5557	5596	5636	5675	5714	5753
0-2	0-5793	5832	5871	5910	5948	5987	6026	6064	6103	6141
0-3	0-6179	6217	6255	6293	6331	6368	6406	6443	6480	6517
0-4	0-6554	6591	6628	6664	6700	6736	6772	6808	6844	6879
0-5	0-6915	6950	6985	7019	7054	7088	7123	7157	7190	7224
0-6	0-7257	7291	7324	7357	7389	7422	7454	7486	7517	7549
0-7	0-7580	7611	7642	7673	7704	7734	7764	7794	7823	7852
0-8	0-7881	7910	7939	7967	7995	8023	8051	8078	8106	8133
0-9	0-8159	8186	8212	8238	8264	8289	8315	8340	8365	8389
1-0	0-8413	8438	8461	8485	8508	8531	8554	8577	8599	8621

Area under the standard normal curve (continued)

z_1	0-00	0-01	0-02	0-03	0-04	0-05	0-06	0-07	0-08	0-09
1-1	0-8643	8665	8686	8708	8729	8749	8770	8790	8810	8830
1-2	0-8849	8869	8888	8907	8925	8944	8962	8980	8997	9015
1-3	0-9032	9049	9066	9082	9099	9115	9131	9147	9162	9177
1-4	0-9192	9207	9222	9236	9251	9265	9279	9292	9306	9319
1-5	0-9332	9345	9357	9370	9382	9394	9406	9418	9429	9441
1-6	0-9452	9463	9474	9484	9495	9505	9515	9525	9535	9545
1-7	0-9554	9564	9573	9582	9591	9599	9608	9616	9625	9633
1-8	0-9641	9649	9656	9664	9671	9678	9686	9693	9699	9706
1-9	0-9713	9719	9726	9732	9738	9744	9750	9756	9761	9767
2-0	0-9772	9778	9783	9788	9793	9798	9803	9808	9812	9817
2-1	0-9821	9826	9830	9834	9838	9842	9846	9850	9854	9857
2-2	0-9861	9864	9868	9871	9875	9878	9881	9884	9887	9890
2-3	0-9893	9896	9898	9901	9904	9906	9909	9911	9913	9916
2-4	0-9918	9920	9922	9925	9927	9929	9931	9932	9934	9936
2-5	0-9938	9940	9941	9943	9945	9946	9948	9949	9951	9952
2-6	0-9953	9955	9956	9957	9959	9960	9961	9962	9963	9964
2-7	0-9965	9966	9967	9968	9969	9970	9971	9972	9973	9974
2-8	0-9974	9975	9976	9977	9977	9978	9979	9979	9980	9981
2-9	0-9981	9982	9982	9983	9984	9984	9985	9985	9986	9986
3-0	0-9987	9987	9987	9988	9988	9989	9989	9989	9990	9990

Chi-squared distribution – inverse values

The table gives the value of k corresponding to the indicated area A .

That is, given a required probability A , the table gives the value of k for which $P(\chi^2 > k) = A$.

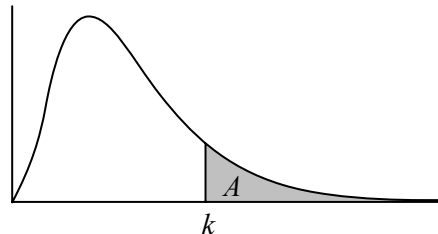

Degrees of freedom	A = 0.995	0.99	0.975	0.95	0.05	0.025	0.01	0.005
1	0.0000	0.0002	0.0010	0.0039	3.8415	5.0239	6.6349	7.8794
2	0.0100	0.0201	0.0506	0.1026	5.9915	7.3778	9.2103	10.597
3	0.0717	0.1148	0.2158	0.3518	7.8147	9.3484	11.345	12.838
4	0.2070	0.2971	0.4844	0.7107	9.4877	11.143	13.277	14.860
5	0.4117	0.5543	0.8312	1.1455	11.070	12.833	15.086	16.750
6	0.6757	0.8721	1.2373	1.6354	12.592	14.449	16.812	18.548
7	0.9893	1.2390	1.6899	2.1673	14.067	16.013	18.475	20.278
8	1.3444	1.6465	2.1797	2.7326	15.507	17.535	20.090	21.955
9	1.7349	2.0879	2.7004	3.3251	16.919	19.023	21.666	23.589
10	2.1559	2.5582	3.2470	3.9403	18.307	20.483	23.209	25.188
11	2.6032	3.0535	3.8157	4.5748	19.675	21.920	24.725	26.757
12	3.0738	3.5706	4.4038	5.2260	21.026	23.337	26.217	28.300
13	3.5650	4.1069	5.0088	5.8919	22.362	24.736	27.688	29.819
14	4.0747	4.6604	5.6287	6.5706	23.685	26.119	29.141	31.319

Chi-squared distribution – inverse values (continued)

Degrees of freedom	A = 0.995	0.99	0.975	0.95	0.05	0.025	0.01	0.005
15	4.6009	5.2293	6.2621	7.2609	24.996	27.488	30.578	32.801
16	5.1422	5.8122	6.9077	7.9616	26.296	28.845	32.000	34.267
17	5.6972	6.4078	7.5642	8.6718	27.587	30.191	33.409	35.718
18	6.2648	7.0149	8.2307	9.3905	28.869	31.526	34.805	37.156
19	6.8440	7.6327	8.9065	10.117	30.144	32.852	36.191	38.582
20	7.4338	8.2604	9.5908	10.851	31.410	34.170	37.566	39.997
21	8.0337	8.8972	10.283	11.591	32.671	35.479	38.932	41.401
22	8.6427	9.5425	10.982	12.338	33.924	36.781	40.289	42.796
23	9.2604	10.196	11.689	13.091	35.172	38.076	41.638	44.181
24	9.8862	10.856	12.401	13.848	36.415	39.364	42.980	45.559
25	10.520	11.524	13.120	14.611	37.652	40.646	44.314	46.928
26	11.160	12.198	13.844	15.379	38.885	41.923	45.642	48.290
27	11.808	12.879	14.573	16.151	40.113	43.195	46.963	49.645
28	12.461	13.565	15.308	16.928	41.337	44.461	48.278	50.993
29	13.121	14.256	16.047	17.708	42.557	45.722	49.588	52.336
30	13.787	14.953	16.791	18.493	43.773	46.979	50.892	53.672
40	20.707	22.164	24.433	26.509	55.758	59.342	63.691	66.766
50	27.991	29.707	32.357	34.764	67.505	71.420	76.154	79.490
60	35.534	37.485	40.482	43.188	79.082	83.298	88.379	91.952
70	43.275	45.442	48.758	51.739	90.531	95.023	100.43	104.21
80	51.172	53.540	57.153	60.391	101.88	106.63	112.33	116.32
90	59.196	61.754	65.647	69.126	113.15	118.14	124.12	128.30
100	67.328	70.065	74.222	77.929	124.34	129.56	135.81	140.17

Student's t -distribution – two-tailed inverse values

The table gives the value of k corresponding to the indicated area A in the **two** tails of the distribution.

That is, the table gives the value of k for which $P(|t| > k) = A$.

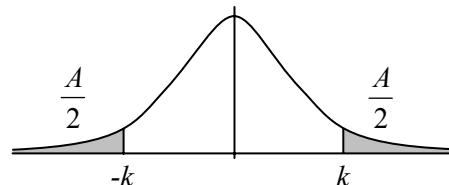

degrees of freedom	Significance level								
	20%	10%	5%	2%	1%	0.2%	0.1%	0.02%	0.01%
1	3.078	6.314	12.71	31.82	63.66	318.3	636.6	3183	6366
2	1.886	2.920	4.303	6.965	9.925	22.33	31.60	70.70	99.99
3	1.638	2.353	3.182	4.541	5.841	10.21	12.92	22.20	28.00
4	1.533	2.132	2.776	3.747	4.604	7.173	8.610	13.03	15.54
5	1.476	2.015	2.571	3.365	4.032	5.893	6.869	9.678	11.18
6	1.440	1.943	2.447	3.143	3.707	5.208	5.959	8.025	9.082
7	1.415	1.895	2.365	2.998	3.499	4.785	5.408	7.063	7.885
8	1.397	1.860	2.306	2.896	3.355	4.501	5.041	6.442	7.120
9	1.383	1.833	2.262	2.821	3.250	4.297	4.781	6.010	6.594
10	1.372	1.812	2.228	2.764	3.169	4.144	4.587	5.694	6.211
11	1.363	1.796	2.201	2.718	3.106	4.025	4.437	5.453	5.921
12	1.356	1.782	2.179	2.681	3.055	3.930	4.318	5.263	5.694
13	1.350	1.771	2.160	2.650	3.012	3.852	4.221	5.111	5.513
14	1.345	1.761	2.145	2.624	2.977	3.787	4.140	4.985	5.363
15	1.341	1.753	2.131	2.602	2.947	3.733	4.073	4.880	5.239

Student's *t*-distribution – two-tailed inverse values (continued)

degrees of freedom	Significance level								
	20%	10%	5%	2%	1%	0.2%	0.1%	0.02%	0.01%
16	1.337	1.746	2.120	2.583	2.921	3.686	4.015	4.790	5.134
17	1.333	1.740	2.110	2.567	2.898	3.646	3.965	4.715	5.043
18	1.330	1.734	2.101	2.552	2.878	3.610	3.922	4.648	4.966
19	1.328	1.729	2.093	2.539	2.861	3.579	3.883	4.590	4.899
20	1.325	1.725	2.086	2.528	2.845	3.552	3.850	4.539	4.838
21	1.323	1.721	2.080	2.518	2.831	3.527	3.819	4.492	4.785
22	1.321	1.717	2.074	2.508	2.819	3.505	3.792	4.452	4.736
23	1.319	1.714	2.069	2.500	2.807	3.485	3.768	4.416	4.694
24	1.318	1.711	2.064	2.492	2.797	3.467	3.745	4.382	4.654
25	1.316	1.708	2.060	2.485	2.787	3.450	3.725	4.352	4.619
26	1.315	1.706	2.056	2.479	2.779	3.435	3.707	4.324	4.587
27	1.314	1.703	2.052	2.473	2.771	3.421	3.689	4.299	4.556
28	1.313	1.701	2.048	2.467	2.763	3.408	3.674	4.276	4.531
29	1.311	1.699	2.045	2.462	2.756	3.396	3.660	4.254	4.505
30	1.310	1.697	2.042	2.457	2.750	3.385	3.646	4.234	4.482
40	1.303	1.684	2.021	2.423	2.704	3.307	3.551	4.094	4.321
50	1.299	1.676	2.009	2.403	2.678	3.261	3.496	4.014	4.228
60	1.296	1.671	2.000	2.390	2.660	3.232	3.460	3.962	4.169
80	1.292	1.664	1.990	2.374	2.639	3.195	3.416	3.899	4.095
100	1.290	1.660	1.984	2.364	2.626	3.174	3.390	3.861	4.054
∞	1.282	1.645	1.960	2.326	2.576	3.090	3.290	3.719	3.891

Units of measurement

Base units

The International System of Units (*Système International d'Unités*) is founded on seven base quantities, which are assumed to be mutually independent. These base units are:

Base quantity	SI base unit	Symbol for unit
length (l)	metre	m
mass (m)	kilogram	kg
time (t)	second	s
electric current (I)	ampere	A
temperature (T)	kelvin	K
amount of substance (n)	mole	mol
luminous intensity	candela	cd

Prefixes

Prefixes are used to form decimal multiples and submultiples of SI units. The common prefixes are:

Factor	Prefix	Symbol
10^{12}	tera	T
10^9	giga	G
10^6	mega	M
10^3	kilo	k
10^2	hecto	h
10^1	deka	da

Factor	Prefix	Symbol
10^{-12}	pico	p
10^{-9}	nano	n
10^{-6}	micro	μ
10^{-3}	milli	m
10^{-2}	centi	c
10^{-1}	deci	d

The symbol for a prefix is combined with the unit symbol to which it is attached to form a new unit symbol, e.g. kilometre (km), milligram (mg), microsecond (μ s).

Common quantities, their symbols and units of measurement

Quantity	Symbol	SI unit	Symbol for SI unit	Non-SI unit used
absorbed dose	D	gray	$\text{Gy} = \text{J kg}^{-1}$	
acceleration	a	metre per second squared	m s^{-2}	
acc. due to gravity	g	metre per second squared	m s^{-2}	
activity	A	becquerel	Bq	
amount of substance	n	mole	mol	
amplitude	A	metre	m	
angle	θ	radian	rad	degree ($^{\circ}$) minute ($'$) second ($''$)
angular velocity	ω	radian per second	rad s^{-1}	rpm
area	A	metre squared	m^2	are (a) = 100 m^2 hectare (ha) = $100 \text{ a} = 10\,000 \text{ m}^2$
atomic number	Z			
capacitance	C	farad	$\text{F} = \text{C V}^{-1}$	
charge	q	coulomb	$\text{C} = \text{A s}$	

Quantity	Symbol	SI unit	Symbol for SI unit	Non-SI unit used
concentration	c	mole per litre	mol l^{-1}	ppm; %(w/v), %(v/v)
critical angle	C			
density	ρ	kilogram per metre cubed	kg m^{-3}	g cm^{-3}
displacement	s	metre	m	
dose equivalent	H	sievert	$\text{Sv} = \text{J kg}^{-1}$	
electric current	I	ampere	A	
electric field strength	E	volt per metre	$\text{V m}^{-1} = \text{N C}^{-1}$	
electronic charge	e	coulomb	$\text{C} = \text{A s}$	
energy (electrical)	W	joule	$\text{J} = \text{N m}$	kW h
energy (heat)	Q	joule	J	
energy (kinetic)	E_k	joule	J	
energy (potential)	E_p	joule	J	
energy (food)		joule	J	kcal = 4182 J = 1 Cal
enthalpy	h	joule	J	
focal length	f	metre	m	
force	F	newton	$\text{N} = \text{kg m s}^{-2}$	

Quantity	Symbol	SI unit	Symbol for SI unit	Non-SI unit used
frequency	f	hertz	$\text{Hz} = \text{s}^{-1}$	
half-life	$T_{1/2}$	second	s	
length (distance)	l, s	metre	m	
magnetic flux	Φ	weber	Wb	
magnetic flux density	B	tesla	$\text{T} = \text{Wb m}^{-2}$	
magnification	m			
mass	m	kilogram	kg	tonne (t) = 1000 kg
mass number	A			
molarity		mole per litre	mol l^{-1}	
moment of a force	M	newton metre	N m	
moment of inertia	I	kilogram metre squared	kg m^2	
momentum	p	kilogram metre per second	kg m s^{-1}	
permittivity	ϵ	farad per metre	F m^{-1}	
periodic time	T	second	s	
power	P	watt	$\text{W} = \text{J s}^{-1}$	
pressure	P, p	pascal	$\text{Pa} = \text{N m}^{-2}$	bar = 10^5 Pa

Quantity	Symbol	SI unit	Symbol for SI unit	Non-SI unit used
refractive index	n			
resistance	R	ohm	$\Omega = \text{V A}^{-1}$	
resistivity	ρ	ohm metre	$\Omega \text{ m}$	
speed	u, v	metre per second	m s^{-1}	knot = 0.514 m s^{-1}
sound intensity	I	watt per metre squared	W m^{-2}	
sound intensity level	$I.L.$			bel (1 B = 10 dB)
specific heat capacity	c	joule per kilogram per kelvin	$\text{J kg}^{-1} \text{ K}^{-1}$	
strain	ϵ			
stress	σ	Newton per metre squared	$\text{Pa} = \text{N m}^{-2}$	
temperature	T	kelvin	K	
temperature	t, θ	degree Celsius	$^{\circ}\text{C}$	
change in temperature	$\Delta\theta$	kelvin	K	
tension	T	newton	N	
thermal conductivity	k	watt per metre per kelvin	$\text{W m}^{-1} \text{ K}^{-1}$	

Quantity	Symbol	SI unit	Symbol for SI unit	Non-SI unit used
time	t	second	s	minute (min) day (d) hour (h) year (y)
torque	T	newton metre	N m	
velocity	u, v	metre per second	m s^{-1}	
voltage potential difference	V	volt	$\text{V} = \text{J C}^{-1}$	
U-value		watt per metre squared per kelvin	$\text{W m}^{-2} \text{K}^{-1}$	
volume	V	metre cubed	m^3	litre (l) = 1000 cm^3
wavelength	λ	metre	m	
weight	W	newton	$\text{N} = \text{kg m s}^{-2}$	
work	W	joule	$\text{J} = \text{N m}$	
Young's modulus	E	Newton per metre squared	$\text{Pa} = \text{N m}^{-2}$	

Frequently used constants

Constant	Symbol	Value
alpha particle mass	m_α	$6.644\ 6565 \times 10^{-27}$ kg
Avogadro constant	N_A	$6.022\ 1415 \times 10^{23}$ mol ⁻¹
Boltzmann constant	k	$1.380\ 6505 \times 10^{-23}$ J K ⁻¹
electron mass	m_e	$9.109\ 3826 \times 10^{-31}$ kg
electron volt	eV	$1.602\ 176\ 53 \times 10^{-19}$ J
electronic charge	e	$1.602\ 176\ 53 \times 10^{-19}$ C
Faraday constant	F	96 485.3383 C mol ⁻¹
gravitational constant	G	6.6742×10^{-11} m ³ kg ⁻¹ s ⁻²
neutron mass	m_n	$1.674\ 927\ 28 \times 10^{-27}$ kg
permeability of free space	μ_0	$4\pi \times 10^{-7}$ N A ⁻²
permittivity of free space	ϵ_0	$8.854\ 187\ 817 \times 10^{-12}$ F m ⁻¹
Planck constant	h	$6.626\ 0693 \times 10^{-34}$ J s
proton mass	m_p	$1.672\ 621\ 71 \times 10^{-27}$ kg
proton-electron mass ratio	m_p/m_e	1836.182 672 16
speed of light <i>in vacuo</i>	c, c_0	$2.997\ 924\ 58 \times 10^8$ m s ⁻¹
universal gas constant	R	$8.314\ 472$ J K ⁻¹ mol ⁻¹

Particle physics

Class	Name	Symbol	Mass (mass of electron = 1)	Mean life	Year of discovery
Leptons	electron	e	1	stable	1897
	neutrino	ν	$< 10^{-3}$	stable	1956
	muon	$\mu^+ \mu^-$	207	2×10^{-6} s	1937
	tau	$\tau^+ \tau^-$	3500	1×10^{-12} s	1975
Mesons	pi meson	$\pi^+ \pi^-$	273	2.6×10^{-8} s	1947
		π^0	264	8.4×10^{-17} s	1947
	K meson	$K^+ K^- K^0$	≈ 970	?	1947
Baryons	proton	p	1836	$> 10^{32}$ y	1897
	neutron	n	1839	960 s	1932
	lambda	Λ^0	2183	2.6×10^{-10} s	1947
	sigma	$\Sigma^+ \Sigma^- \Sigma^0$	2327	$\sim 10^{-10}$ s	1953
	chi	$\Xi^+ \Xi^- \Xi^0$	2573	$\sim 10^{-10}$ s	1954
	omega	Ω^-	3272	$\sim 10^{-10}$ s	1964

quark

u up
s strange
t top
d down
c charmed
b bottom

antiquark

\bar{u}
 \bar{s}
 \bar{t}
 \bar{d}
 \bar{c}
 \bar{b}

Mechanics

Linear motion with constant acceleration

$$v = u + at$$

$$s = ut + \frac{1}{2}at^2$$

$$v^2 = u^2 + 2as$$

$$s = \left(\frac{u + v}{2} \right)t$$

$$\text{average speed} = \frac{\text{distance}}{\text{time}}$$

Relative motion

$$s_{bc} = s_b - s_c$$

$$v_{bc} = v_b - v_c$$

$$a_{bc} = a_b - a_c$$

Momentum of a particle

$$mv$$

Newton's experimental law (NEL)

$$v_1 - v_2 = -e(u_1 - u_2)$$

Conservation of momentum

$$m_1u_1 + m_2u_2 = m_1v_1 + m_2v_2$$

Impulse (change in momentum)

$$mv - mu$$

Angle in radians $\theta = \frac{s}{r}$

Angular velocity $\omega = \frac{\theta}{t}$

Linear velocity and angular velocity $v = r\omega$

Centripetal acceleration $a = r\omega^2 = \frac{v^2}{r}$

Centripetal force $F = mr\omega^2 = \frac{mv^2}{r}$

Newton's law of gravitation $F = \frac{Gm_1m_2}{d^2}$

Force and acceleration $F = ma$

Weight and acceleration due to gravity $W = mg = V\rho g ; \quad g = \frac{GM}{R^2}$

Period of a satellite $T^2 = \frac{4\pi^2 R^3}{GM}$

Moment of a force $M = Fd$

Torque of a couple $T = Fd$

Centres of gravity

Hemisphere, radius r $\frac{3}{8}r$ from centre

Hemispherical shell, radius r $\frac{1}{2}r$ from centre

Right circular cone $\frac{1}{4}h$ from the base

Triangular lamina $\frac{1}{3}$ from base along median = $\left(\frac{x_1 + x_2 + x_3}{3}, \frac{y_1 + y_2 + y_3}{3} \right)$

Arc, radius r , angle 2θ $\frac{r \sin \theta}{\theta}$

Sector of disc, radius r , angle 2θ $\frac{2r \sin \theta}{3\theta}$

Moments of Inertia

Uniform rod, length $2l$ Centre: $\frac{1}{3}ml^2$ One end: $\frac{4}{3}ml^2$

Uniform disc, radius r Centre: $\frac{1}{2}mr^2$ Diameter: $\frac{1}{4}mr^2$

Uniform hoop, radius r

$$\text{Centre: } mr^2 \quad \text{Diameter: } \frac{1}{2}mr^2$$

Uniform solid sphere, radius r

$$\text{Diameter: } \frac{2}{5}mr^2$$

Parallel axis theorem

$$I_b = I_c + m|bc|^2$$

Perpendicular axis theorem

$$I_z = I_x + I_y$$

Hooke's law

$$F = -ks$$

Simple harmonic motion

$$a = -\omega^2 s$$

$$T = \frac{1}{f} = \frac{2\pi}{\omega}$$

$$s = A \sin(\omega t + \alpha)$$

$$v^2 = \omega^2(A^2 - s^2)$$

Simple pendulum

$$T = 2\pi\sqrt{\frac{l}{g}}$$

Compound pendulum

$$T = 2\pi\sqrt{\frac{I}{mgh}}$$

Work

$$W = Fs = \int Fds$$

Potential (gravitational) energy

$$E_p = mgh$$

Kinetic energy

$$E_k = \frac{1}{2}mv^2$$

Principle of conservation of mechanical energy

$$E_p + E_k = \text{constant}$$

Mass-energy equivalence

$$E = mc^2$$

Power

$$P = \frac{W}{t} = Fv$$

Percentage efficiency

$$\frac{\text{power output} \times 100}{\text{power input}}$$

Young's modulus

$$E = \frac{\sigma}{\epsilon}$$

Stress

$$\sigma = \frac{F}{A}$$

Strain

$$\epsilon = \frac{\Delta l}{l}$$

Density

$$\rho = \frac{m}{V}$$

Pressure

$$p = \frac{F}{A}$$

Pressure in a fluid

$$p = \rho gh$$

Thrust on an immersed plane surface

$$T = Ap_{\text{centroid}}$$

Boyle's law

$$pV = \text{constant}$$

Heat and temperature

Celsius temperature

$$t / ^\circ\text{C} = T / \text{K} - 273.15$$

Energy needed to change temperature

$$\Delta E = mc\Delta\theta \quad \Delta E = C\Delta\theta$$

Energy needed to change state

$$\Delta E = ml \quad \Delta E = L$$

Waves

Velocity of a wave

$$c = f\lambda$$

Doppler effect

$$f' = \frac{fc}{c \pm u}$$

Fundamental frequency of a stretched string

$$f = \frac{1}{2l} \sqrt{\frac{T}{\mu}}$$

Mirror and lens formula

$$\frac{1}{f} = \frac{1}{u} + \frac{1}{v}$$

Magnification

$$m = \frac{v}{u}$$

Power of a lens

$$P = \frac{1}{f}$$

Two lenses in contact

$$P = P_1 + P_2$$

Refractive index

$$n = \frac{\sin i}{\sin r} = \frac{\text{real depth}}{\text{apparent depth}}$$

$$n = \frac{1}{\sin C} = \frac{c_1}{c_2}$$

Diffraction grating

$$n\lambda = d \sin \theta$$

Electricity

Coulomb's law	$F = \frac{1}{4\pi\epsilon} \frac{q_1 q_2}{d^2}$
Electric field strength	$E = \frac{F}{q}$
Potential difference	$V = \frac{W}{q}$
Ohm's law	$V = IR$
Resistivity	$\rho = \frac{RA}{l}$
Resistors in series	$R = R_1 + R_2$
Resistors in parallel	$\frac{1}{R} = \frac{1}{R_1} + \frac{1}{R_2}$
Wheatstone bridge	$\frac{R_1}{R_2} = \frac{R_3}{R_4}$
Joule's law	$P = RI^2$

Force on a current-carrying conductor

$$F = IlB$$

Force on a charged particle

$$F = qvB$$

Induced emf

$$E = -\frac{d\Phi}{dt}$$

Alternating voltage and current

$$V_{\text{rms}} = \frac{V_0}{\sqrt{2}} \quad I_{\text{rms}} = \frac{I_0}{\sqrt{2}}$$

Capacitance

$$C = \frac{q}{V}$$

Parallel-plate capacitor

$$C = \frac{A\epsilon_0}{d}$$

Energy stored in capacitor

$$W = \frac{1}{2}CV^2$$

Power

$$P = VI$$

Magnetic flux

$$\Phi = BA$$

Transformer

$$\frac{V_i}{V_o} = \frac{N_p}{N_s}$$

Modern physics

Energy of a photon

$$E = hf$$

Einstein's photoelectric equation

$$hf = \Phi + \frac{1}{2}mv_{\max}^2$$

Law of radioactive decay

$$A = \lambda N$$

Half-life

$$T_{1/2} = \frac{\ln 2}{\lambda}$$

Mass-energy equivalence



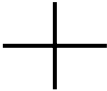

$$E = mc^2$$

Electrical circuit symbols



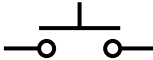

Conductors

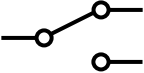
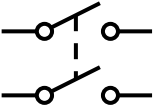
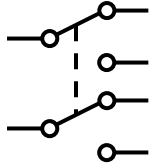
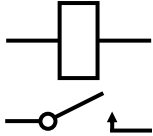
 <p>junction of conductors</p>	 <p>conductors crossing with no connection</p>
---	---



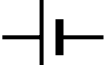
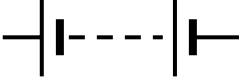

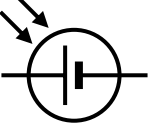
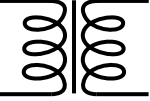
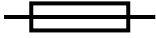
Switches

 <p>push-to-make switch</p>	 <p>push-to-break switch</p>	 <p>normally open on-off switch (SPST)</p>	 <p>normally closed on-off switch (SPST)</p>
 <p>two-way switch (SPDP)</p>	 <p>dual on-off switch (DPST)</p>	 <p>dual two-way switch (DPDT)</p>	 <p>relay (SPST)</p>



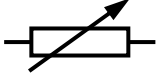

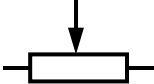
Power

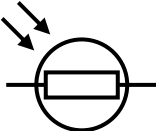
 <p>cell</p>	 <p>battery</p>	 <p>d.c. supply</p>	 <p>a.c. supply</p>
 <p>photovoltaic cell</p>	 <p>transformer</p>	 <p>fuse</p>	 <p>earth</p>



Resistors

 <p>fixed resistor</p>	 <p>variable resistor (rheostat)</p>	 <p>preset variable resistor</p>	 <p>potential divider</p>
 <p>thermistor</p>	 <p>light-dependent resistor</p>		



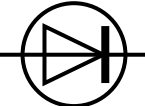

Capacitors

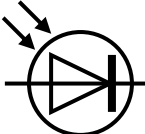
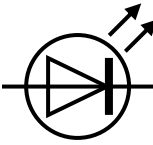
 capacitor	 electrolytic capacitor (polarised capacitor)	 variable capacitor	 preset variable capacitor (trimmer)
--	--	--	---

Diodes

 diode	 Zener diode	 photodiode	 light-emitting diode (LED)
--	--	--	--





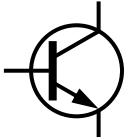
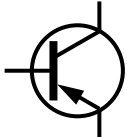
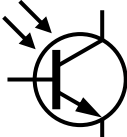
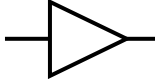

Meters

 voltmeter	 galvanometer	 ammeter	 ohmmeter
 oscilloscope			

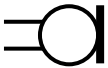

Amplification

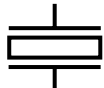
 <p>n-p-n-junction transistor</p>	 <p>p-n-p-junction transistor</p>	 <p>light-sensitive transistor</p>	 <p>amplifier (block symbol)</p>
--	--	--	---



Audio

 <p>microphone</p>	 <p>earphone</p>	 <p>loudspeaker</p>	 <p>bell</p>
 <p>buzzer</p>	 <p>piezoelectric transducer</p>	 <p>aerial (antenna)</p>	



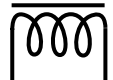

Lamps

 <p>filament lamp</p>	 <p>signal lamp</p>	 <p>neon lamp</p>
--	--	---

Other devices

 <p>motor</p>	 <p>heater</p>	 <p>inductor</p>	 <p>inductor with ferromagnetic core</p>
--	---	--	---

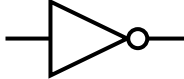
Logic gates

 <p>OR</p>	 <p>AND</p>	 <p>NOT (inverter)</p>	 <p>NAND</p>
 <p>NOR</p>			

The elements

Periodic table of the elements

1											18						
1 H 1.008												2 He 4.003					
3 Li 6.941	4 Be 9.012											13 B 10.81	14 C 12.01	15 N 14.01	16 O 16.00	17 F 19.00	18 Ne 20.18
11 Na 22.99	12 Mg 24.31	3	4	5	6	7	8	9	10	11	12	13 Al 26.98	14 Si 28.09	15 P 30.97	16 S 32.07	17 Cl 35.45	18 Ar 39.95
19 K 39.10	20 Ca 40.08	21 Sc 44.96	22 Ti 47.87	23 V 50.94	24 Cr 52.00	25 Mn 54.94	26 Fe 55.85	27 Co 58.93	28 Ni 58.69	29 Cu 63.55	30 Zn 65.41	31 Ga 69.72	32 Ge 72.64	33 As 74.92	34 Se 78.96	35 Br 79.90	36 Kr 83.80
37 Rb 85.47	38 Sr 87.62	39 Y 88.91	40 Zr 91.22	41 Nb 92.91	42 Mo 95.94	43 Tc (97.90)	44 Ru 101.1	45 Rh 102.9	46 Pd 106.4	47 Ag 107.9	48 Cd 112.4	49 In 114.8	50 Sn 118.7	51 Sb 121.8	52 Te 127.6	53 I 126.9	54 Xe 131.3
55 Cs 132.9	56 Ba 137.3	57 La 138.9	72 Hf 178.5	73 Ta 180.9	74 W 183.8	75 Re 186.2	76 Os 190.2	77 Ir 192.2	78 Pt 195.1	79 Au 197.0	80 Hg 200.6	81 Tl 204.4	82 Pb 207.2	83 Bi 209.0	84 Po (209.0)	85 At (210.0)	86 Rn (222.0)
87 Fr (223.0)	88 Ra (226.0)	89 Ac (227.0)	104 Rf (261.1)	105 Db (262.1)	106 Sg (266.6)	107 Bh (264.1)	108 Hs (277.0)	109 Mt (268.1)	110 Ds (271.0)	111 Rg (272.2)	112 Uub (285.0)	113 Uut*	114 Uuq (289.0)	115 Uup*	116 Uuh (289.0)	117 Uus*	118 Uuo (293.0)

* These elements have not yet been detected (2008).
See page 54 for the Lanthanoid and the Actinoid Series.

First ionisation energies of the elements
(in kJ mol⁻¹)

1																	18
1 H 1312																	2 He 2372
3 Li 520.2	4 Be 899.5											13 B 800.6	14 C 1087	15 N 1402	16 O 1314	17 F 1681	18 Ne 2081
11 Na 495.8	12 Mg 737.7											13 Al 577.5	14 Si 786.5	15 P 1012	16 S 999.6	17 Cl 1251	18 Ar 1521
19 K 418.8	20 Ca 589.8	21 Sc 633.1	22 Ti 658.8	23 V 650.9	24 Cr 652.9	25 Mn 717.3	26 Fe 762.5	27 Co 760.4	28 Ni 737.1	29 Cu 745.5	30 Zn 906.4	31 Ga 578.8	32 Ge 762.0	33 As 947.0	34 Se 941.0	35 Br 1140	36 Kr 1351
37 Rb 403.0	38 Sr 549.5	39 Y 600.0	40 Zr 640.1	41 Nb 652.1	42 Mo 684.3	43 Tc 702.0	44 Ru 710.2	45 Rh 719.7	46 Pd 804.4	47 Ag 731.0	48 Cd 867.8	49 In 558.3	50 Sn 708.6	51 Sb 834.0	52 Te 869.3	53 I 1008	54 Xe 1170
55 Cs 375.7	56 Ba 502.9	57 La 538.1	72 Hf 658.5	73 Ta 761.0	74 W 770.0	75 Re 760.0	76 Os 840.0	77 Ir 880.0	78 Pt 870.0	79 Au 890.1	80 Hg 1007	81 Tl 589.4	82 Pb 715.6	83 Bi 703.0	84 Po 812.1	85 At 890±40	86 Rn 1037
87 Fr 380.0	88 Ra 509.3	89 Ac 499.0	104 Rf 580.0	105 Db --	106 Sg --	107 Bh --	108 Hs --	109 Mt --	110 Ds --	111 Rg --	112 Uub --	113 Uut* --	114 Uuq --	115 Uup* --	116 Uuh --	117 Uus* --	118 Uuo --

* These elements have not yet been detected (2008).
See page 54 for the Lanthanoid and the Actinoid Series.

Electronegativity values of the elements (Using the Pauling scale)

1																		18		
1 H 2.20																				2 He --
3 Li 0.98	4 Be 1.57											5 B 2.04	6 C 2.55	7 N 3.04	8 O 3.44	9 F 3.98	10 Ne --			
11 Na 0.93	12 Mg 1.31											13 Al 1.61	14 Si 1.90	15 P 2.19	16 S 2.58	17 Cl 3.16	18 Ar --			
19 K 0.82	20 Ca 1.00	21 Sc 1.36	22 Ti 1.54	23 V 1.63	24 Cr 1.66	25 Mn 1.55	26 Fe 1.83	27 Co 1.88	28 Ni 1.91	29 Cu 1.90	30 Zn 1.65	31 Ga 1.81	32 Ge 2.01	33 As 2.18	34 Se 2.55	35 Br 2.96	36 Kr --			
37 Rb 0.82	38 Sr 0.95	39 Y 1.22	40 Zr 1.33	41 Nb 1.60	42 Mo 2.16	43 Tc 2.10	44 Ru 2.20	45 Rh 2.28	46 Pd 2.20	47 Ag 1.93	48 Cd 1.69	49 In 1.78	50 Sn 1.96	51 Sb 2.05	52 Te 2.10	53 I 2.66	54 Xe 2.60			
55 Cs 0.79	56 Ba 0.89	57 La 1.10	72 Hf 1.30	73 Ta 1.50	74 W 1.70	75 Re 1.90	76 Os 2.20	77 Ir 2.20	78 Pt 2.20	79 Au 2.40	80 Hg 1.90	81 Tl 1.80	82 Pb 1.80	83 Bi 1.90	84 Po 2.00	85 At 2.20	86 Rn --			
87 Fr 0.70	88 Ra 0.90	89 Ac 1.10	104 Rf --	105 Db --	106 Sg --	107 Bh --	108 Hs --	109 Mt --	110 Ds --	111 Rg --	112 Uub --	113 Uut*	114 Uuq --	115 Uup*	116 Uuh --	117 Uus*	118 Uuo --			

* These elements have not yet been detected (2008).
See page 54 for the Lanthanoid and the Actinoid Series.

Periodic table of the elements

Lanthanoid Series	58 Ce 140.1	59 Pr 140.9	60 Nd 144.2	61 Pm (144.9)	62 Sm 150.4	63 Eu 152.0	64 Gd 157.3	65 Tb 158.9	66 Dy 162.5	67 Ho 164.9	68 Er 167.3	69 Tm 168.9	70 Yb 173.0	71 Lu 175.0
Actinoid Series	90 Th 232.0	91 Pa 231.0	92 U 238.0	93 Np (237.0)	94 Pu (244.1)	95 Am (243.1)	96 Cm (247.1)	97 Bk (247.1)	98 Cf (251.1)	99 Es (252.1)	100 Fm (257.1)	101 Md (256.0)	102 No (259.1)	103 Lr (262.1)

First ionisation energies of the elements (in kJ mol⁻¹)

Lanthanoid Series	58 Ce 534.4	59 Pr 527.0	60 Nd 533.1	61 Pm 540.0	62 Sm 544.5	63 Eu 547.1	64 Gd 593.4	65 Tb 565.8	66 Dy 573.0	67 Ho 581.0	68 Er 589.3	69 Tm 596.7	70 Yb 603.4	71 Lu 523.5
Actinoid Series	90 Th 587.0	91 Pa 568.0	92 U 597.6	93 Np 604.5	94 Pu 584.7	95 Am 578.0	96 Cm 581.0	97 Bk 601.0	98 Cf 608.0	99 Es 619.0	100 Fm 627.0	101 Md 635.0	102 No 642.0	103 Lr 470.0

Electronegativity values of the elements (Using the Pauling scale)

Lanthanoid Series	58 Ce 1.12	59 Pr 1.13	60 Nd 1.14	61 Pm --	62 Sm 1.17	63 Eu --	64 Gd 1.20	65 Tb --	66 Dy 1.22	67 Ho 1.23	68 Er 1.24	69 Tm 1.25	70 Yb --	71 Lu 1.00
Actinoid Series	90 Th 1.30	91 Pa 1.50	92 U 1.70	93 Np 1.30	94 Pu 1.30	95 Am 1.30	96 Cm 1.30	97 Bk 1.30	98 Cf 1.30	99 Es 1.30	100 Fm 1.30	101 Md 1.30	102 No 1.30	103 Lr 1.30

